

Calculus BC – Chapter 4 Sample Test (calculators allowed)

Show all work for free-response questions.

- The first derivative of the function f is given by $f'(x) = \frac{\cos^2 x}{x} - \frac{1}{5}$. How many critical values does f have on the open interval $(0, 10)$?
 (A) One (B) Three (C) Four (D) Five (E) Seven
- If $a \neq 0$, then $\lim_{x \rightarrow a} \frac{x^2 - a^2}{x^4 - a^4}$ is
 (A) $\frac{1}{a^2}$ (B) $\frac{1}{2a^2}$ (C) $\frac{1}{6a^2}$ (D) 0 (E) nonexistent
- The function f is continuous for $-2 \leq x \leq 1$ and differentiable for $-2 < x < 1$. If $f(-2) = -5$ and $f(1) = 4$, which of the following statements could be false?
 (A) There exists c , where $-2 < c < 1$, such that $f(c) = 0$.
 (B) There exists c , where $-2 < c < 1$, such that $f'(c) = 0$.
 (C) There exists c , where $-2 < c < 1$, such that $f(c) = 3$.
 (D) There exists c , where $-2 < c < 1$, such that $f'(c) = 3$.
 (E) There exists c , where $-2 \leq c \leq 1$, such that $f(c) \geq f(x)$ for all x on the closed interval $-2 \leq c \leq 1$.

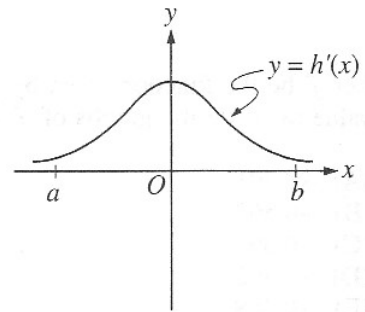
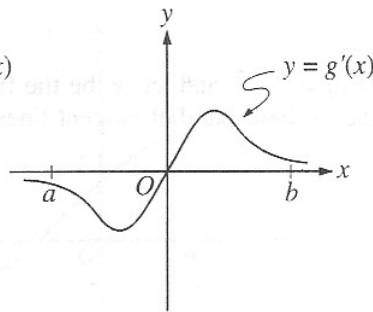
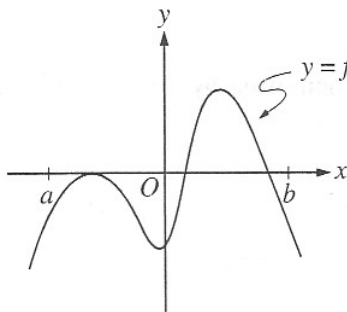

- The graphs of the derivatives of the functions f , g , and h are shown above. Which of the functions f , g , or h have a local maximum on the open interval $a < x < b$?
 (A) f only (B) g only (C) h only
 (D) f and g only (E) f , g , and h

Calculus BC -- Chapter 4 Sample Test (calculators allowed)

5. The function f has first derivative given by $f'(x) = \frac{\sqrt{x}}{1+x+x^3}$. What is the x -coordinate of the inflection point of the graph of f ?
- (A) 1.008 (B) 0.473 (C) 0
(D) -0.278 (E) The graph of f has no inflection point.

x	$f(x)$
-5	-9
0	1
2	5

6. The table above gives values of a continuous function f at selected values of x . Based on the information in the table, which of the following statements must be true?
- (A) f has at most one zero
(B) f has a relative maximum at $x = 2$
(C) There exists a value c , where $-5 < c < 2$, such that $f(c) = 4$
(D) There exists a value c , where $-5 < c < 2$, such that $f'(c) = 2$
7. A rectangular plot of land is to be fenced in using two kinds of fencing. Two opposite sides will use heavy-duty fencing selling for \$3 per foot, while the remaining two sides will use standard fencing selling for \$2 per foot. What is the greatest area that can be fenced in at a cost of \$6000?

Calculus BC -- Chapter 4 Sample Test (calculators allowed)

8. A 18-ft ladder leaning against a wall begins to slide. How fast is the angle between the ladder and the wall changing at the moment when the bottom of the ladder is 9 ft from the wall and sliding away from the wall at the rate of 5 ft/sec?

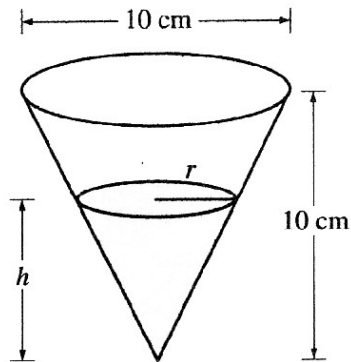
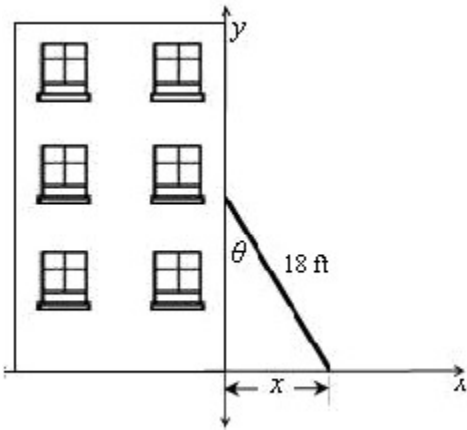

9. A container has the shape of an open right circular cone, as shown in the figure above. The height of the container is 10 cm and the diameter of the opening is 10 cm. Water in the container is evaporating so that its depth h is changing at the constant rate of $-\frac{3}{10}$ cm/hr. Find the rate of change of the volume of the water in the container, with respect to time, when $h = 5$ cm. Indicate units of measure.

(Note: The volume V of a cone with radius r and height h is given by $V = \frac{1}{3}\pi r^2 h$.)

Calculus BC -- Chapter 4 Sample Test (calculators allowed)



10. A boat is pulled into a dock by a rope attached to the bow of the boat and passing through a pulley on the dock that is 1 m higher than the bow of the boat. If the rope is pulled in at a rate of 1 m/s how fast is the boat approaching the dock when it is 6 m from the dock?

Name _____

Period _____

Calculus BC – Chapter 4 Sample Test (no calculators)

Show all work for free-response questions.

1. What is the x -coordinate of the point of inflection of the graph $y = \frac{1}{3}x^3 + 5x^2 + 24$?
(A) 5 (B) 0 (C) $-\frac{10}{3}$ (D) -5 (E) -10

2. If $f''(x) = x(x+1)(x-2)^2$, then the graph of f has inflection points at $x =$
(A) -1 only (B) 2 only (C) -1 and 0 only
(D) -1 and 2 only (E) -1, 0, and 2 only

Questions 3 and 4 refer to the graph and the information below.

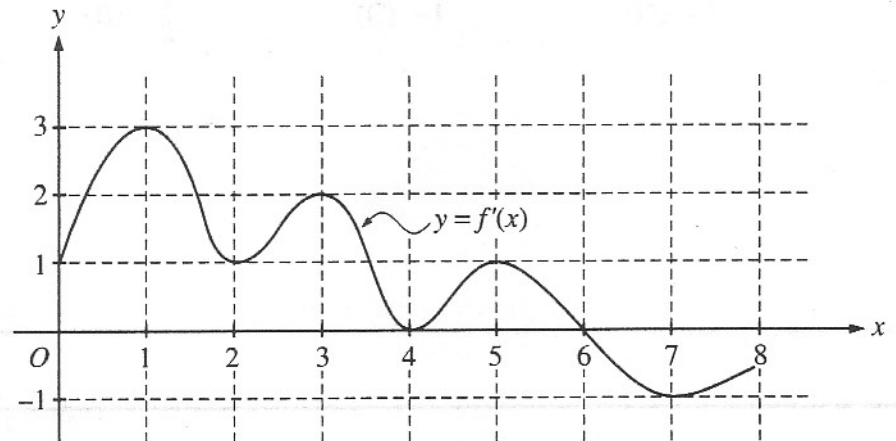

The function f is defined on the closed interval $[0, 8]$. The graph of its derivative f' is shown above.

3. How many points of inflection does the graph of f have?
(A) Two (B) Three (C) Four (D) Five (E) Six

4. At what value of x does the absolute minimum of f occur?
(A) 0 (B) 2 (C) 4 (D) 6 (E) 8

Calculus BC -- Chapter 4 Sample Test (no calculators)

5. A particle moves along the x -axis so that at any time $0 \leq t \leq 6$ its position is given by $x(t) = t^3 - 6t^2 + 9t + 12$.

a) For what values of t is the particle moving to the left?

b) What is the minimum velocity of the particle on the interval? Show the analysis that leads to your conclusion.

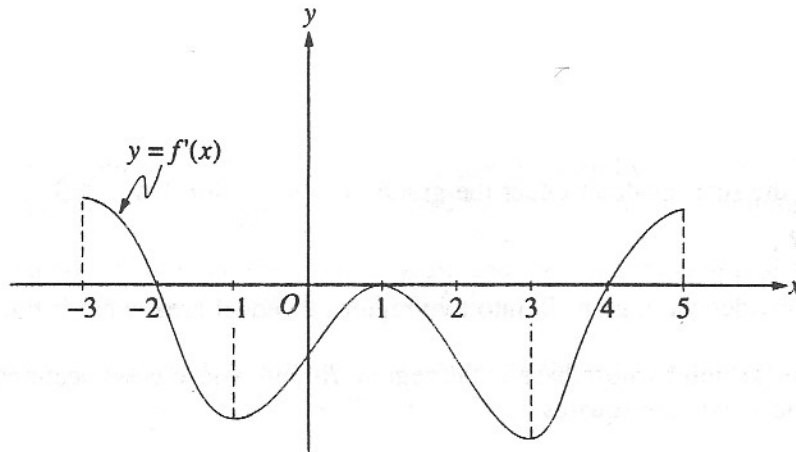

6. The figure above shows the graph of f' , the derivative of a function f . The domain of f is $-3 < x < 5$.

a. For what values of x does f have a local maximum? Why?

b. For what values of x does f have a local minimum? Why?

c. On what intervals is the graph of f concave upward? Use f' to justify your answer.

Calculus BC -- Chapter 4 Sample Test (no calculators)

7. Let h be a function defined for all $x \neq 0$ such that the derivative is given by

$$h'(x) = \frac{x^2 - 2}{x} \text{ for all } x \neq 0.$$

- a. Find all values of x for which the graph of h has a horizontal tangent, and determine whether h has a local maximum, a local minimum, or neither at each of these values. Justify your answer.
- b. On what intervals, if any, is the graph of h concave up? Justify your answer.
- c. Does the line tangent to the graph of h at $x = 4$ lie above or below the graph of h for $x > 4$? Why?
8. Suppose f is a twice-differentiable function such that $f(2) = 6$ and $f(4) = -3$. Must there exist a value of c , for $2 < c < 4$, such that $f'(c) = 0$? Justify your answer.

Calculus BC -- Chapter 4 Sample Test (no calculators)

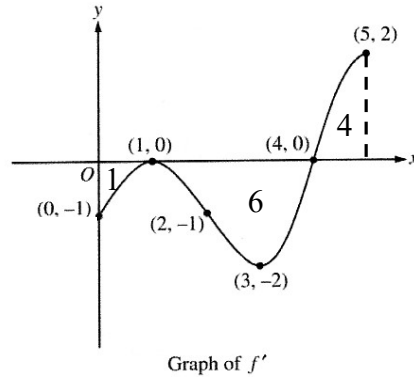

9. The figure above shows the graph of f' , the derivative of the function f , on the closed interval $0 \leq x \leq 5$. The graph of f' has horizontal tangent lines at $x=1$ and $x=3$, and the area of each region is given. The function f is twice differentiable with $f(5) = 6$.
- Find the x -coordinate of each of the points of inflection of the graph of f .
Give a reason for your answer.
 - At what value of x does f attain its absolute minimum value on the closed interval $0 \leq x \leq 5$? Show the analysis that leads to your answer.
 - Let g be the function defined by $g(x) = xf'(x)$. Find an equation for the line tangent to the graph of g at $x=5$.